

PITELUMEC

THE PRING-E 235 RING BIT CASING SYSTEM



CASING SIZE 273MM OD X 254MM ID DRILLING DIA. 293MM

PNEUMEC PRING-E 235 CASING SYSTEM

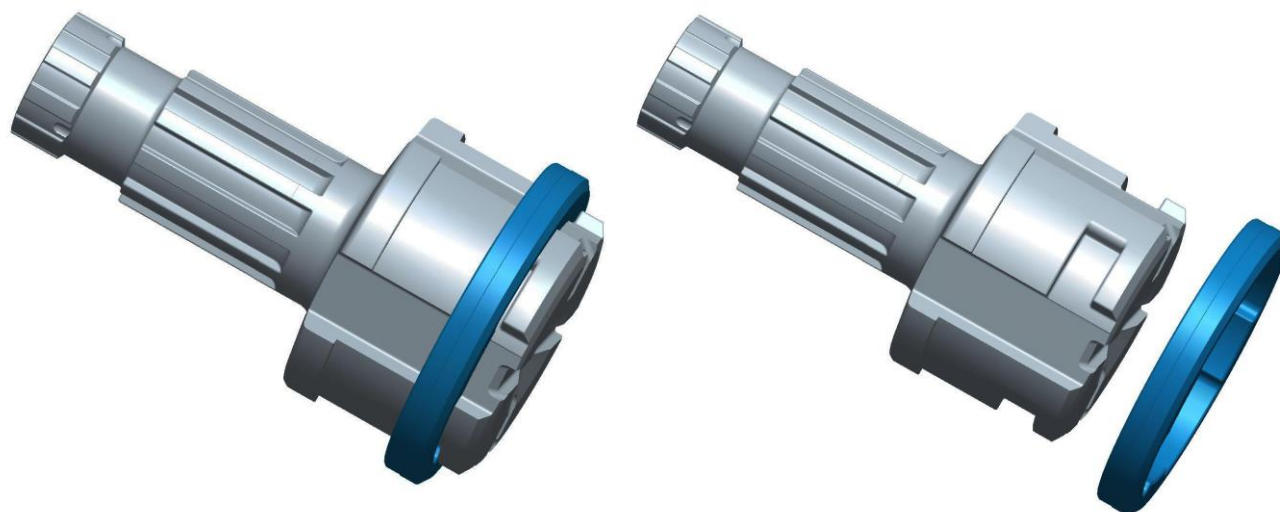

PRING-E 235 PARTS LIST

1.	DRIVER BIT DHD380 SHANK	UGD235380RE
2.	RING	URB240RE
3.	COMPLETE SYSTEM	UCS235380RE

PRING-E 235 SPECIFICATIONS

UPPER BODY DIAMETER	251MM	RING ID	192MM
RING OD	293MM	CASING SIZE	273MM OD X 254MM ID
SYSTEM LENGTH	590MM	SYSTEM WEIGHT	110KG

PRING-E 235 CASING SHOES

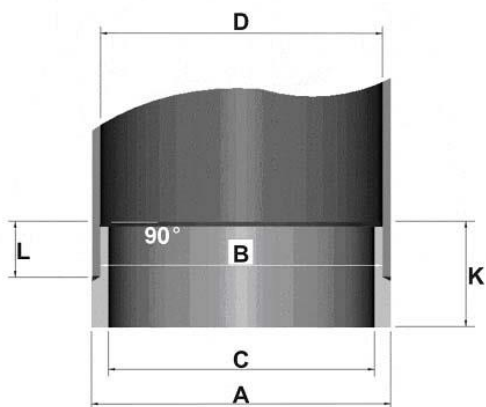

DIA. A	273MM
DIA. B	251MM
DIA. C	233MM
DIA. D	254MM
L	35MM
K	80MM



PNEUMEC COMPANY LIMITED

1st Floor, Tin On Sing Comm. Bldg., 41-43 Graham St. Central, H.K.

Tel : (852) 2235 9922

Website : www.pneumec.com

Fax : (852) 2235 9982

email : info@pneumec.com